

MAXIM

MAX5015 Evaluation Kit

Evaluates: MAX5015

General Description

The MAX5015 evaluation kit (EV kit) is a fully assembled and tested printed circuit board (PCB) that contains a 50W forward converter in the industry-standard half-brick footprint. The circuit is configured for a +5.0V output voltage and provides up to 10A of current. Power for the circuit can be provided from either a +36V to +72V or -36V to -72V DC source.

High efficiency of 86% is achieved at 5A using a single transistor, forward converter topology providing output power up to 50W. The surface-mount transformer provides galvanic isolation and has a reset winding to recover magnetic energy. Galvanic isolation up to 1500V is achieved by an optocoupler and surface-mount transformer.

Operation at 280kHz allows the use of small magnetics and output capacitors.

Warning: The MAX5015 EV kit is designed to operate with high voltages. Dangerous voltages are present on this EV kit and on equipment connected to it. Users who power up this EV kit or power the sources connected to it must be careful to follow safety procedures appropriate to working with high-voltage electrical equipment.

Under severe fault or failure conditions, this EV kit may dissipate large amounts of power, which could result in the mechanical ejection of a component or of component debris at high velocity. Operate this kit with care to avoid possible personal injury.

Component Suppliers

SUPPLIER	PHONE	WEBSITE
Central Semiconductor	631-435-1110	www.centrasemi.com
Coiltronics	561-752-5000	www.cooperet.com
Dale/Vishay	402-564-3131	www.vishay.com
General Semiconductor/Vishay	760-804-9258	www.vishay.com
International Rectifier	310-322-3331	www.irf.com
Murata Mfg. Co., Ltd.	770-436-1300	www.murata.com
Sanyo North America Corp.	619-661-6835	www.sanyodevice.com
Taiyo Yuden	800-348-2496	www.t-yuden.com
TDK Corp.	847-803-6100	www.component.tdk.com

Note: Indicate that you are using the MAX5015 when contacting these component suppliers.

Features

- ◆ +36V to +72V or -36V to -72V Input Range
- ◆ +5V Output at 10A
- ◆ V_{OUT} Regulation better than 0.1% over Line and Load
- ◆ 86% Efficiency at 48V Input and 5V/5A Output
- ◆ Half-Brick Module Footprint and Pinout
- ◆ Short-Circuit Protection
- ◆ 275kHz Switching Frequency
- ◆ Designed for 1500V Isolation
- ◆ Soft-Start
- ◆ Fully Assembled and Tested
- ◆ Remote ON/OFF
- ◆ Remote Sense

Ordering Information

PART	TEMP RANGE	IC PACKAGE
MAX5015EVKIT	0°C to +70°C	8 SO
MAX5015EVKIT+	0°C to +70°C	8 SO

+Denotes a lead-free package and RoHS-compliant EV kit.

Component List

DESIGNATION	QTY	DESCRIPTION
C1, C15	2	0.1μF ±10%, 50V X7R ceramic capacitors (0805) Taiyo Yuden UMK212BJ104KG
C2	1	0.01μF ±10%, 50V X7R ceramic capacitor (0805)
C3	0	Not installed (0805)
C4, C5, C6	3	0.68μF, 100V X7R ceramic capacitors (1812) TDK C4532X7R2A684K
C7, C13, C14	3	560μF, 6.3V electrolytic capacitors (8 x 11.5) Sanyo 6MV560WX
C8	1	0.047μF ±10%, 50V X7R ceramic capacitor (0805) Taiyo Yuden UMK212BJ473KG
C9	1	10μF ±20%, 16V X5R ceramic capacitor (1210) Taiyo Yuden EMK325BJ106MN

MAX5015 Evaluation Kit

Component List (continued)

DESIGNATION	QTY	DESCRIPTION
C10	1	0.1 μ F \pm 10%, 16V X7R ceramic capacitor (0603) Taiyo Yuden EMK107BJ104KA
C11	1	0.33 μ F \pm 10%, 35V X7R ceramic capacitor (0805) Taiyo Yuden GMK212BJ334KG
C12	1	0.001 μ F, 200V X7R ceramic capacitor (0603) Murata GRM39-X7R102K200
C16	1	0.0047 μ F, 250VAC X7R ceramic capacitor (2220) Murata GA355DR7GC472KY02L
C17	1	0.022 μ F \pm 10%, 25V X7R ceramic capacitor (0603)
D1	0	Not installed 15V, 150mW zener diode (S-mini)
D2	0	Not installed 3V, 150mW zener diode (S-mini)
D3	1	80V, 100mA Schottky diode (S-mini)
D4	1	40V, 20A Schottky diode (TO-220AB) General Semiconductor SBL2040CT
D5	1	250V, 250mA high-voltage switching diode (SOD-123) Central Semiconductor CMHD2003
L1	1	4.7 μ H, 21.5A inductor Coiltronics, HC2-4R7-R
N1	1	200V, 18A n-channel MOSFET (TO-220AB) International Rectifier IRF640NP6F
Q1	0	Not installed npn transistor (SOT23)
R1, R10	0	Not installed (0805)
R3	1	20 Ω \pm 5% resistor (1206)

DESIGNATION	QTY	DESCRIPTION
R5	1	240k Ω \pm 5% resistor (0805)
R6	1	0.1 Ω \pm 1% power resistor (1206) Dale Electronics, Inc. WSL1206 R1000FEA
R7	1	1 Ω \pm 5% resistor (0805)
R8	1	499 Ω \pm 1% resistor (0805)
R9	1	150 Ω \pm 5% resistor (0805)
R11	1	25.5k Ω \pm 1% resistor (0805)
R12	1	8.25k Ω \pm 1% resistor (0805)
R13	1	4.75k Ω \pm 1% resistor (0805)
R15	1	3.32k Ω \pm 1% resistor (0805)
R16, R17	2	51 Ω \pm 5% resistors (0805)
T1	1	170 μ H 1:0.857: 0.357:0.357 turn transformer (12-pin Gull Wing) Coiltronics CTX03-14856
U1	1	MAX5015ESA+ (8-pin SO)
U2	1	70V \pm 100% to 200% CTR phototransistor (8-pin SO) Fairchild MOC207M
U3	1	1.24V precision shunt regulator (SOT23) Texas Instruments TLV431AIDBV
—	1	Aluminum heatsink plate Vista Industrial Products 5015
—	2	Nylon spacers, 1/4 x 5/8 nylon
—	2	Nylon screws, 4-40 x 1/4
—	2	Nylon screws, 4-40 x 1/2
—	2	Nylon screws, 6-32 x 3/8
—	2	TO-220AB Mica thermal insulating pads
—	1	PCB: MAX5015 Evaluation Kit

MAX5015 Evaluation Kit

Evaluates: MAX5015

Quick Start

The MAX5015 EV kit is fully assembled and tested. Follow these steps to verify board operation. **Do not turn on the power supply until all connections are completed.**

Output

- 1) Connect a jumper wire from the VOUT pin to the +SENSE pin.
- 2) Connect a jumper wire from the SGND pin to the -SENSE pin.
- 3) Connect a voltmeter to the VOUT pin and SGND.
- 4) Connect a +36V to +72V power supply to the VIN+ pin. **Do not exceed 100V input voltage.**
Connect the power supply's ground to the VIN- pin.
- 5) Turn on the power supply above +36V and verify that VOUT provides +5V at the voltmeter.

For instructions on selecting the feedback resistors for other output voltages, refer to the *Evaluating other Output Voltages* section in this document.

Detailed Description

The MAX5015 EV kit is a 50W forward converter which provides +5.0V and up to 10A at the output. The circuit can be powered from a +36V to +72V or a -36V to -72V DC source. **The user must supply at least 220 μ F of bulk storage capacitor at the input terminals (VIN+, VIN-).** The capacitor should be rated for 100V and be able to carry 1.5A of ripple current.

The 50W forward converter achieves high efficiency by using a single transistor topology. Current limiting protects the converter against short circuits at the output. A current sense resistor (R6) senses the current through the primary of the transformer (T1) and the switching transistor (N1) and turns off the transistor when the trip level of 500mV is reached. The surface-mount transformer features a reset winding that, along with diode (D5), recovers the magnetic energy stored in the core and feeds it back to the input (VIN+). The transformer provides galvanic isolation up to 1500V.

Shunt regulator (U3) along with feedback resistors (R11, R12) provide voltage feedback to the primary side through optocoupler (U2). Remote output voltage sensing is provided by the +SENSE and -SENSE for accurate output voltage regulation across the load. The soft-start allows the output voltage to slowly ramp up in a controlled manner within 20ms. The MAX5015 controller switches at a fixed 275kHz frequency, and the duty cycle is varied to control energy transfer to the output.

Shutdown

Shutdown Mode (Remote Control Method)

The MAX5015 EV kit features a pin to remotely shut-down the forward converter. An open-collector/drain transistor or relay contact must be connected to the $\overline{\text{SHDN}}$ and VIN- pins of the EV kit. Table 1 lists the options.

Table 1. Shutdown Pin Function (Remote Control)

$\overline{\text{SHDN}}$ PIN	MAX5015 OUTPUT
Open	MAX5015 enabled, V _{OUT} = +5.0V
Pull low	Shutdown mode, V _{OUT} = 0V

Evaluating Other Output Voltages, Current Limits, and Soft-Starts

VOUT Output Voltage

The MAX5015 EV kit's output (V_{OUT}) is set to +5.0V by feedback resistors (R11, R12). To generate output voltages other than +5.0V (+3.2V to +5.0V), select different voltage-divider resistors (R11, R12). Resistor R11 is typically chosen to be less than 25k Ω . Using the desired output voltage, resistor R12 is then found by the following equation:

$$R12 = [R11 / ((V_{OUT} / V_{REF}) - 1)] \text{ where } V_{REF} = 1.24V$$

The maximum output current should be limited to less than 10A. The usable output voltage range for the EV kit is +3.2V to +5.0V. Additionally, ICs U2, U3, and resistor R9 limit the minimum output voltage (V_{OUT}) to +3.2V.

Current Limiting

The EV kit features current limiting for the transformer primary current. The MAX5015 IC turns off the switching MOSFET (N1) when the voltage at the CS pin of the device reaches 465mV. A current sense resistor (R6, 0.1 Ω) limits the peak primary current to 4.65A (465mV / 0.1 Ω = 4.65A). This will limit short-circuit current on the secondary output (V_{OUT}) to 13A typically. To evaluate lower current limits, the current sense resistor (R6) must

MAX5015 Evaluation Kit

be replaced with a surface-mount resistor (1206 size) as determined by the following equation:

$$R6 = V_{SENSE} / ((N_S / N_P) \times (1.2 \times I_{OUTMAX}))$$

where $V_{SENSE} = 0.5V$, $N_S = 5$, $N_P = 14$, and I_{OUTMAX} = maximum DC output current (10A as configured).

Soft-Start

The MAX5015 EV kit limits the ramp time to full current limit and duty cycle with a soft-start feature. Capacitor C2 (0.01 μ F), sets the ramp time to 20ms. To evaluate other soft-start ramp times replace capacitor C2 with another surface mount capacitor (0805 size) as determined by the following equation:

$$C2 (\mu F) = \text{soft-start time (s)} / (0.45s/\mu F)$$

Forward Converter Waveforms

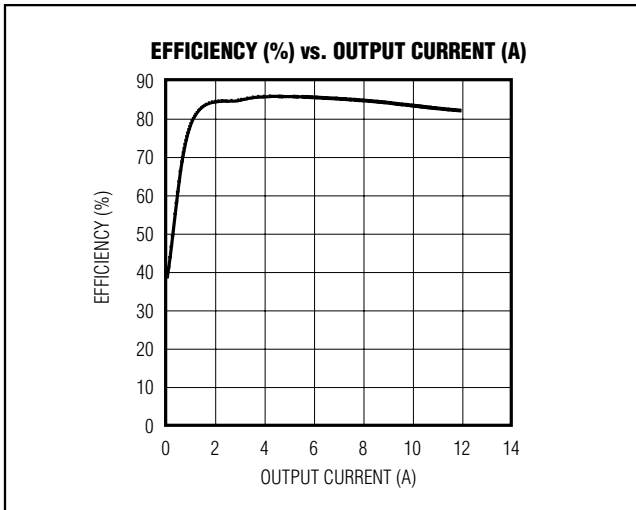

Figure 1. Efficiency vs. Output Current. $V_{IN+} = 48V$

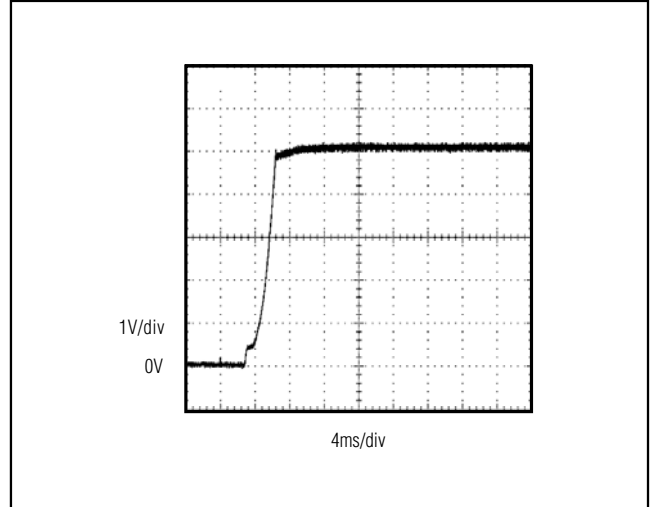

Figure 2. Output Voltage Transient at Power-Up. $V_{IN+} = 48V$, $I_{OUT} = 5A$

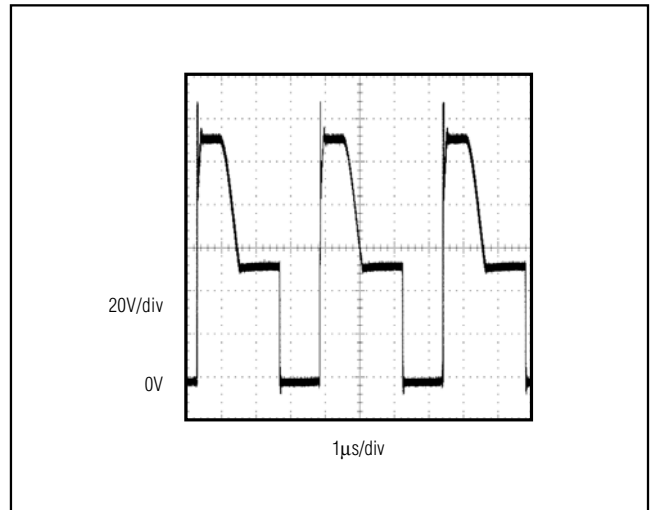

Figure 3. MOSFET N1, Drain-Source Voltage Waveform, $V_{IN+} = 48V$

MAX5015 Evaluation Kit

Evaluates: MAX5015

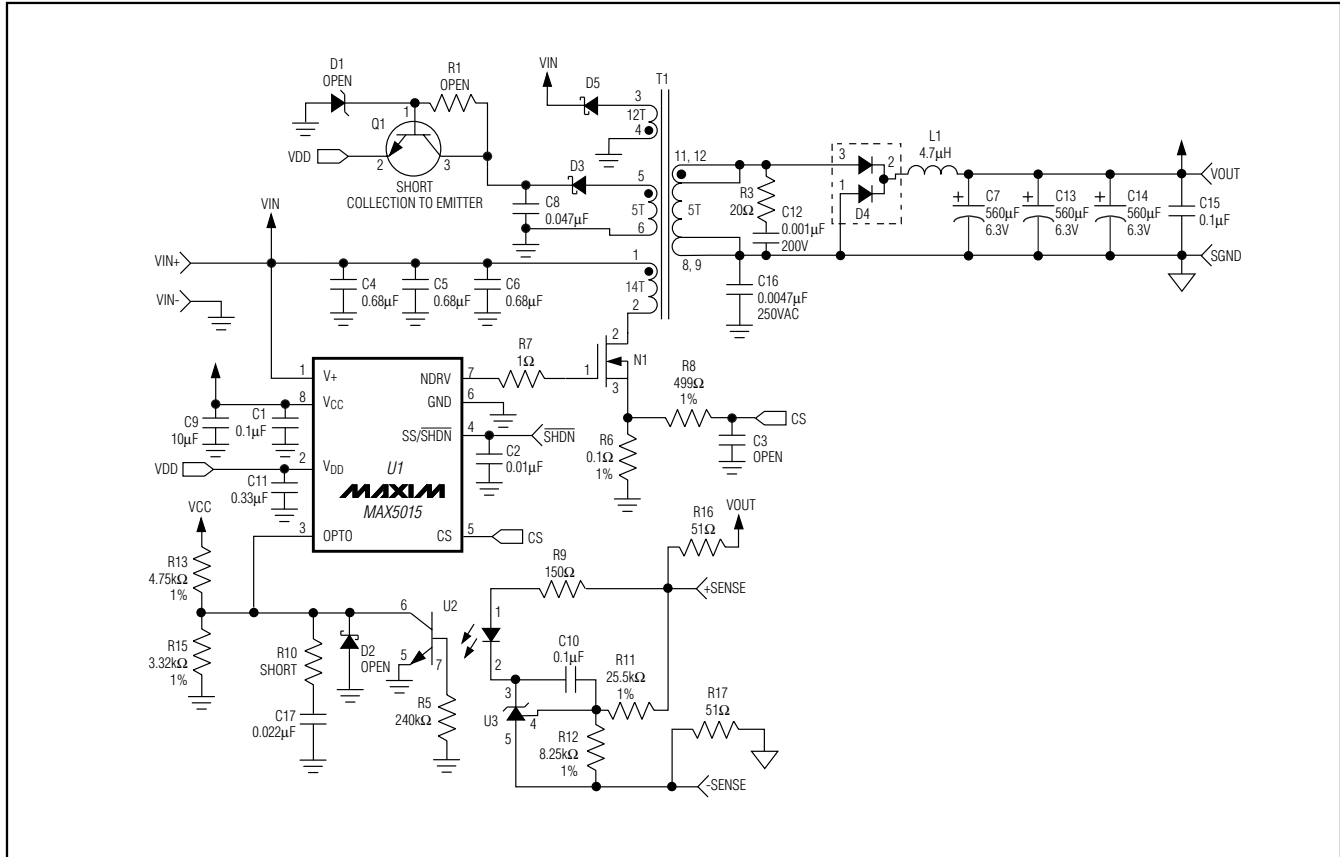

Figure 4. MAX5015 EV Kit Schematic

MAX5015 Evaluation Kit

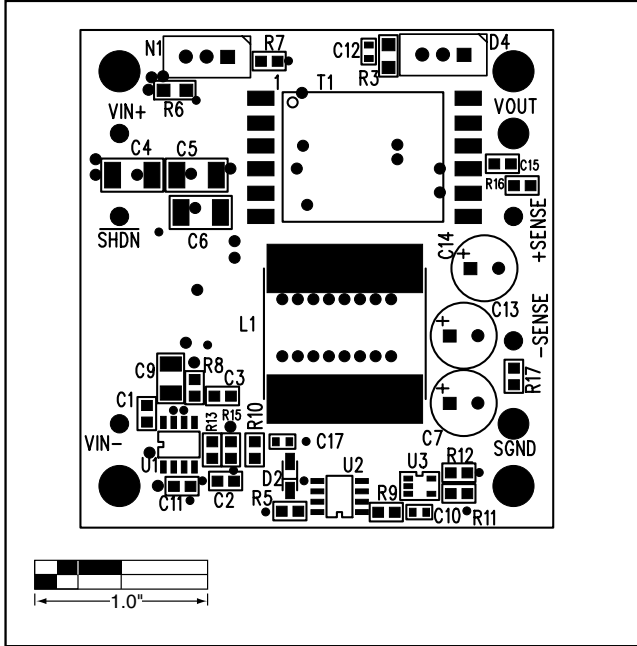

Figure 5. MAX5015 EV Kit Component Placement Guide—Component Side

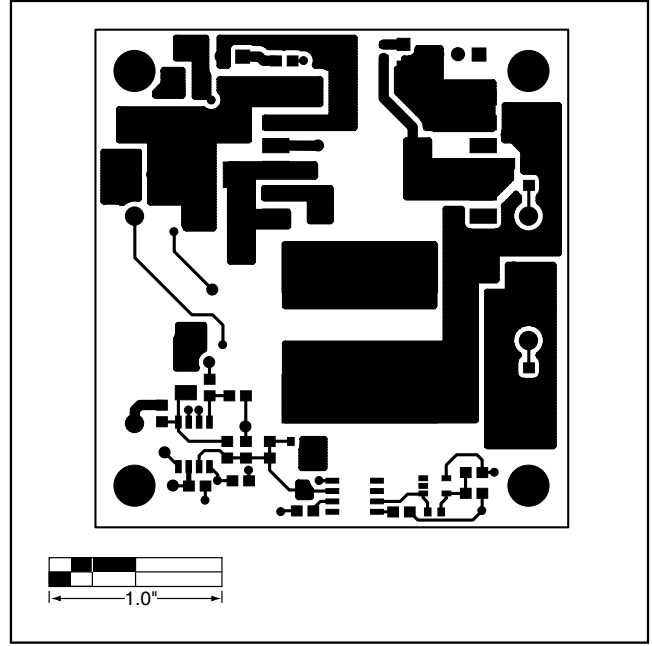

Figure 6. MAX5015 EV Kit PCB Layout—Component Side

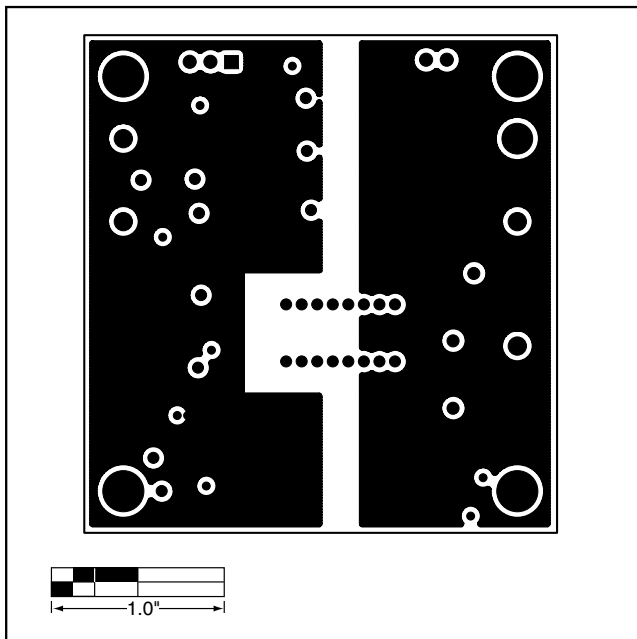

Figure 7. MAX5015 EV Kit PCB Layout—Inner Layer, Ground Plane

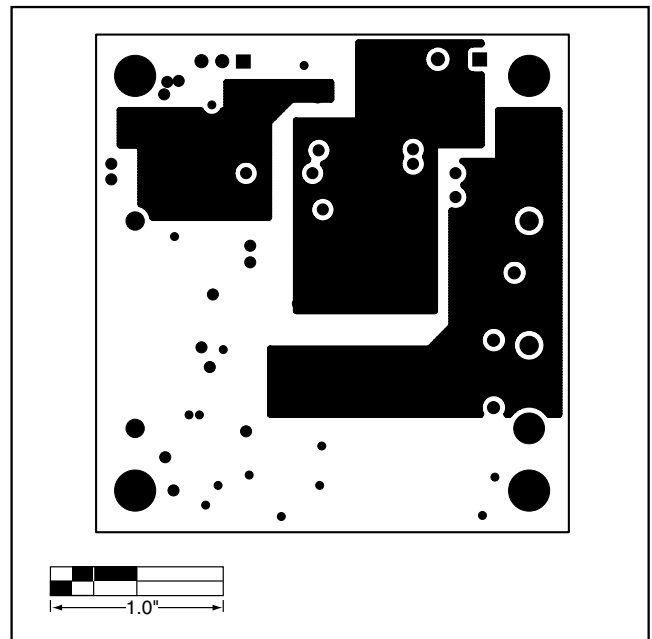

Figure 8. MAX5015 EV Kit PCB Layout—Inner Layer, Power Plane

MAX5015 Evaluation Kit

Evaluates: MAX5015

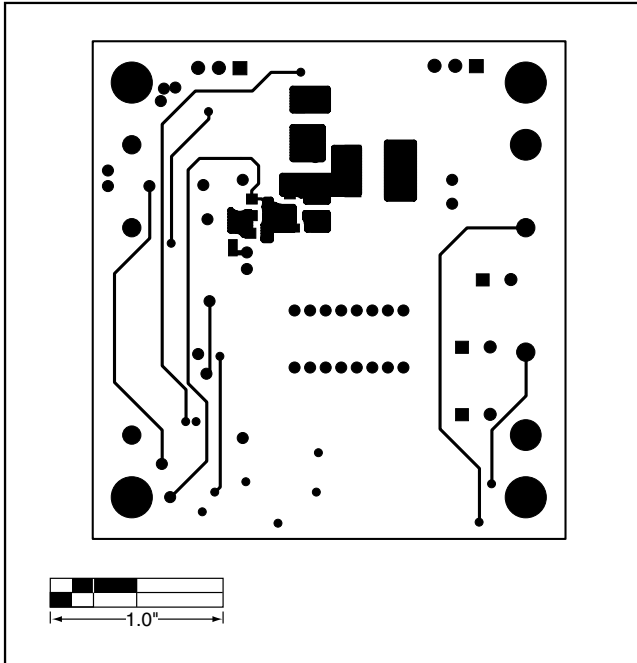

Figure 9. MAX5015 EV Kit PCB Layout—Solder Side

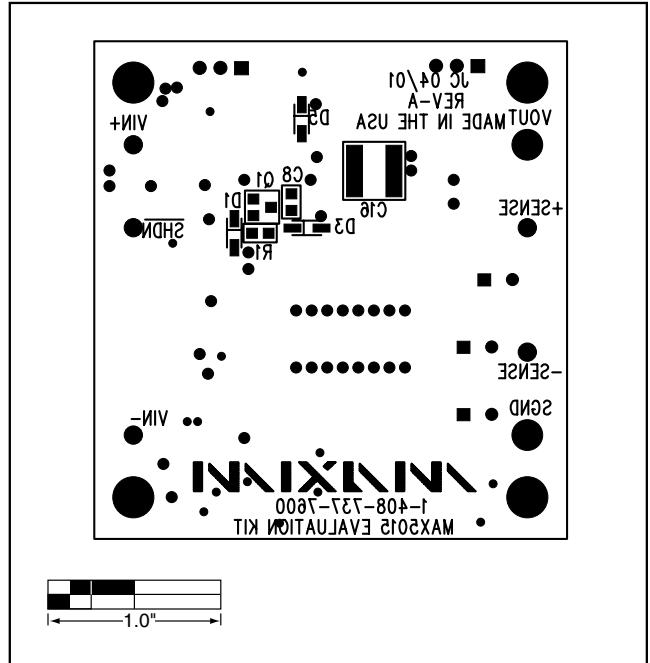

Figure 10. MAX5015 EV Kit Component Placement Guide—Solder Side

Revision History

Pages changed at Rev 3: 1, 2, 6, 7

Maxim cannot assume responsibility for use of any circuitry other than circuitry entirely embodied in a Maxim product. No circuit patent licenses are implied. Maxim reserves the right to change the circuitry and specifications without notice at any time.

Maxim Integrated Products, 120 San Gabriel Drive, Sunnyvale, CA 94086 408-737-7600 _____ 7